



Rittal – TopConsole System



Top design with infinite
installation possibilities



CONTENTS

A powerful member of the Rittal "human/machine interface" family	4
Interiors and exteriors without any restrictions –	
The TopConsole with integrated modularity	6
Best when combined: Ergonomic, design and function	8
Combination options	10
TopConsole System TP	
Consoles	12
Desk units	13
Pedestals	14
System accessories	15
Technical details	24
Index	27
List of model numbers	27



RITTAL AT ITS BEST: THE NEW TOPCONSOLE SYSTEM

Form follows function. Remaining true to this clear principle, Rittal has developed a console system with an unmistakable slim-line appearance. The enhanced design was chosen not simply for the sake of change, but as a perfect realisation of the human/machine interface. Incorporating very special qualities with regard to modular configuration, ease of assembly and system accessories – and that all combined with outstanding cost benefits. Top form down to the finest detail. A design with that something extra!



Top design with functionality:
The grip sits firmly in the hand, and ingeniously hides the lock of the hinged lid. The design is matched to the form language of the whole human/machine interface family.



The diversity of combination:
The elements of the TopConsole system can be combined individually with other human/machine interface modules.



Simple single-handed operation:

The self-latching stay holds the desk unit lid open at the individually desired angle.

Simple assembly with built-in "assistant":

The integrated "mounting assistant" can be used as an adjustment and securing aid. Simply slot together, lock in place and screw tight.

Individual interior configuration:

Rittal's extensive range of modular system accessories permits the tailoring of immediately cost-effective individual solutions.



Comfort Panel

Flexibility: Every interaction is given optimum support. Irrespective of whether it is a standard enclosure or customised enclosure, with support arm or with a stand system – everything is possible.

Industrial workstations

Modularity: More working space than a PC enclosure, but more compact than a desk. The IW modularity enables individual customer requirements to be implemented perfectly.

PC enclosure systems

Safety: PC enclosure systems ensure the safe housing of monitors, computer systems, printers and mice in factory automation plants.



A POWERFUL MEMBER OF THE RITTAL “HUMAN/MACHINE INTERFACE” FAMILY

The interface between man and machine has a decisive effect on productivity.

Therefore Rittal supplies a wide range of units for meeting the modern demands of human/machine interfaces.

Superb quality, inexpensively priced, and ergonomically customised to meet individual requirements. Programming, operating, monitoring.

People still remain the centre of focus with the new Rittal TopConsole.

Our research and development department has produced top

solutions based on the many decades of know-how that we have

gained in discussions with our customers: Customised operating

enclosures, industrial workstations, PC enclosure systems and the

new TopConsole system. An unbeatable human/machine interface

team when it comes to individuality and productivity and used in

conjunction with Rittal system accessories.



**To individual TopConsole system installations the Rittal philosophy also applies:
Attractive diversity – Infinite possibilities at long last.**

The extensive range of Rittal system accessories, such as plinths, locking systems, wiring plan pockets, the variety of TS 8 busbar systems for interior installation and the options of the CM cable entries ensure that your requirements can be met perfectly, quickly and cost effectively.



Designed with a function:

The design strip combines the handle and the lock. Stylishly integrated: the keyboard drawer.

Workstation with ideas:

The console lid for the desk unit and the console provides you with a lot more surface area for switches, displays and controls, i.e. for this Rittal keyboard.

Functionality with a “click”:

The integrated “mounting assistant” can be used as an adjustment and securing aid. It enables easy and quick installation to be realised with just a “click”.

Single-handed operation:

The desk unit lid stay locks in automatically and it can be unlocked in one operation.

Simple assembly:

The fitted mounting plate slides in and locks easily into position (in a 25 mm pitch pattern). This depth variable installation and securing technology saves a lot of time and money when being assembled and during servicing.

Extra advantage:

All TopConsole modules are fitted with threaded studs and are therefore ready for use in TS compatible configurations (rails, busbar systems, partial mounting plates and many more besides).



INTERIORS AND EXTERIORS WITHOUT ANY RESTRICTIONS – TOPCONSOLE WITH INTEGRATED MODULARITY

Planning safety and the maximum degree of freedom for individual applications – optimum conditions for the system designer. These conditions were clearly the main focus during the development of the new Rittal TopConsole systems. The sophisticated design ensures easy and flexible installation and population. The extensive and installation friendly TS 8 system accessories provide infinite upgrade options for the series. Your benefit: Less costs incurred due to reduced stock and logistical expenditure.

**Practical diversity:**

Perforated system strips fitted to doors and covers for TS compatible installation, i.e. for mounting rails or wiring plan pockets.

TopConsole System

Perfect cable entry options:

TopConsole system – Which also means more combination options for cable entries thanks to individual gland plates.

Easy baying:

The TopConsole system lets you easily connect to the baying strips which are fitted between the pedestal and the desk unit.



TopConsole – great diversity at all levels

The console

Choose between two different heights (650 and 750 mm).

- Modular interior installation
- The consoles of the console systems can also be used as a “stand-alone” solution if mounted with wall mounting brackets. That way they can also be used as a display enclosure.

The desk unit

There are two versions for the different combinations:

- as a finished console unit used in combination with the TopConsole’s pedestal
- for further combinations with the TopConsole’s console unit

Other features:

- Modular interior installation
- Easy installation of a keyboard drawer

The pedestal

Choose between two different heights (400 and 500 mm).

- 500 mm deep: Door(s) fitted on the front and rear
- 400 mm deep: Choose with door(s) fitted on the front or rear
- Depth-variable mounting plate
- Modular interior installation
- Fittings and installation (e.g. climate control) without any expensive enclosure modifications

Stylish ergonomics:

Screens, displays and operating controls are mounted in an ergonomically favourable angle. The slim, stylish design and the large surface are just perfect.

User-friendly security:

Whereas two to three locks were previously needed (depending on the width) the single lock now uses locking bars to realise the double locking capability.

Design line:

The integrated lock, which is shielded by a hinged flap, is visually aligned with the handle strip.



BEST WHEN COMBINED: ERGONOMIC, DESIGN AND FUNCTION

Rittal have set new standards for the human/machine interface TopConsole system by taking ergonomics, visual appearance and functionality into consideration. The new console system is clearly “thinner” and far more versatile overall. Not only has the usable mounting area and the interior installation modularity been clearly expanded but so has the variability within the “human/machine interface” family. It is now even easier to implement different combinations of TopConsole modules with support arm system modules, command panels or industrial workstations.



Major diversity from using combinations with command panels and industrial workstations

Example 1: The pedestal of a TopConsole combined with an IW worktop.

Example 2: The pedestal of a TopConsole combined with a TopConsole desk unit, CP-L support arm components and a command panel.

Example 3: A TopConsole desk unit combined with the pedestal of an IW that is 600 mm deep.

TopConsole System TP

Combination options

Easy selection of your desired combination

The TP TopConsole systems components can be combined in many user specific versions as shown in the diagrams below. The table opposite allows you to immediately find the order number for your selection. In addition to this, the IW and command panel range make the new TP TopConsole system combination options virtually infinite.

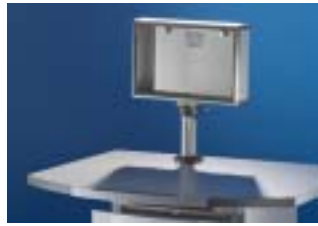

Small operating units can easily be integrated in separate command panels.



Completely new options with regard to space utilisation are available when used in conjunction with our range of IW enclosures.



The TS modular base/plinth system also ensures more cable entry flexibility even when used with consoles.

Rittal human/machine interface family

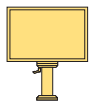

Command panels can be found in Cat. 31, from page 154.

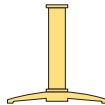

Stand systems can be found in Cat. 31, from page 228.

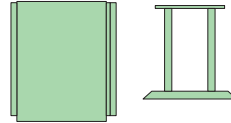

Industrial workstations (IW) can be found in Cat. 31, from page 238.

Combined with console base sections

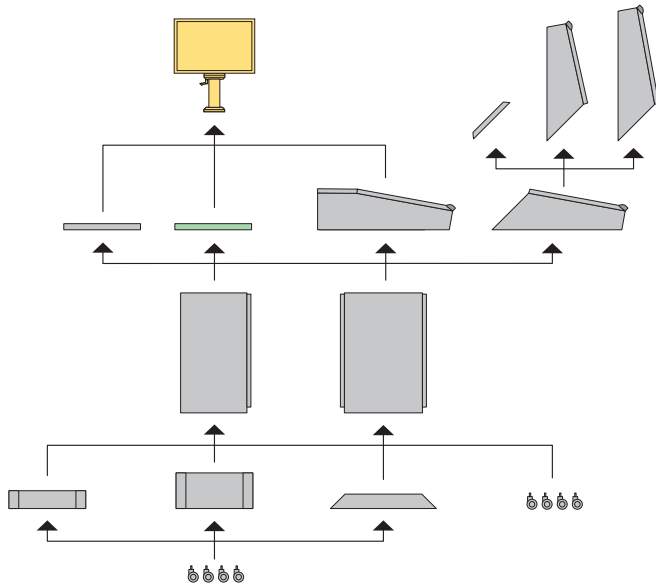

Combined with IW enclosures

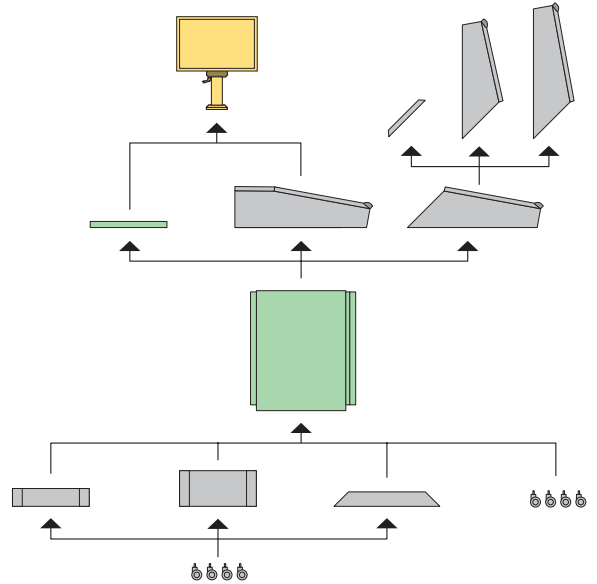

Combined with pedestals

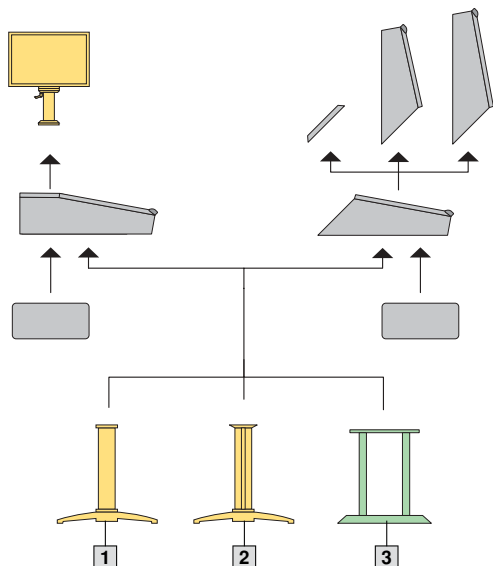



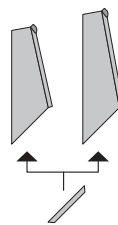





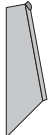
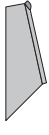
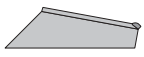

Upper section used as wall enclosure

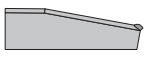

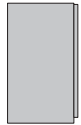
- 1** Pedestal, height adjustable for 600 mm width
- 2** Pedestal for IW worktops with 600 mm width
- 3** Worktop bases for ≥ 800 mm width

TopConsole System TP

Overview table

Width mm	600		800		1200		1600		
	Model No.	Model No.	Model No.	Model No.	Model No.	Model No.	Model No.	Model No.	
Console, upper section									
	Height 750 mm	6720.500	6721.500	6722.500	6723.500				
	Height 650 mm	6724.500	6725.500	6726.500	6727.500				
Desk unit already prepared for an upper section									
	Depth 755 mm	6714.500	6715.500	6716.500	6717.500				
Console/desk unit trim panel									
	for height 650/750 mm	6730.200	6730.210	6730.220	6730.230				
Rear of desk unit, with hinged lid									
	Depth 755 mm	6710.500	6711.500	6712.500	6713.500				
Desk unit gland plate (see Innovations 2005/2006, page 188 for other gland plates)									
	Solid Size 4	2562.400	–	2 x 2562.400	–				
	Solid Size 5	–	2563.150	–	2 x 2563.150				
	pre-punched	–	2203.010	–	2 x 2203.010				
Trim panel									
	D mm	400	500	400	500	400	500	400	500
		6730.000	6730.100	6730.010	6730.110	6730.020	6730.120	6730.030	6730.130
Pedestal									
	D mm	400	500	400	500	400	500	400	500
	Height 675 mm	6700.500	6704.500	6701.500	6705.500	6702.500	6706.500	6703.500	6707.500
Base/plinth components, front and rear									
	Height 200 mm	8602.600	8602.800	8602.200	8602.920				
	Height 100 mm	8601.600	8601.800	8601.200	8601.920				
Base/plinth trims, side									
	D mm	400	500	400	500	400	500	400	500
	Height 200 mm	8602.040	8602.050	8602.040	8602.050	8602.040	8602.050	8602.040	8602.050
	Height 100 mm	8601.040	8601.050	8601.040	8601.050	8601.040	8601.050	8601.040	8601.050
Cross-member, adjustable									
	Height 75 mm	8601.450	8601.450	8601.450	8601.450				
Castors									
	Height 125 mm	4634.500	4634.500	4634.500	4634.500				

TopConsole System TP

Consoles

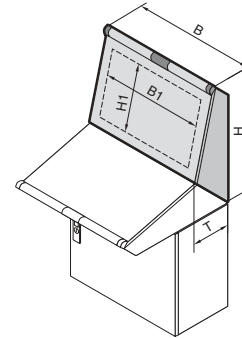

Material:

Sheet steel
Enclosure: 1.5 mm
Cover: 2.0 mm
Design handle strips: Aluminium
Corner protectors and lock lids:
Plastic, self-extinguishing

Surface finish:

Enclosure and cover:
Dipcoat-primed, powder-coated
in textured RAL 7035 on the
outside
Design handle strips:
Natural-anodised
Corner protectors and lock lids:
RAL 7015

Protection category:

IP 55 as per EN 60 529/10.91
(when using the relevant trim
panel, see page 16, or mount on
a desk unit)



Rittal service:

- Other sizes, cut-outs and holes available on request
- Console for direct mounting on the pedestal using a trim panel.

Supply includes:

Enclosure with lid, hinged top or bottom, includes lid stays, open bottom for running separate cables.

Detailed drawing, see page 24.

Width (B) mm	Packs of	600	800	1200	1600	600	800	1200	1600	Page	
Height (H) mm		650	650	650	650	750	750	750	750		
Depth (T) mm		240	240	240	240	240	240	240	240		
Max. cut-out	Width (B1) mm	488	688	1088	1488	488	688	1088	1488		
	Height (H1) mm	313	313	313	313	413	413	413	413		
Model No. TP		6724.500	6725.500	6726.500	6727.500	6720.500	6721.500	6722.500	6723.500		
Accessories											
Trim panel (when used alone)		1	6730.200	6730.210	6730.220	6730.230	6730.200	6730.210	6730.220	6730.230	17
Rail for interior installation, horizontal	for width	4	5001.050	5001.051	5001.053	5001.055	5001.050	5001.051	5001.053	5001.055	20
Punched sections with mounting flanges 17 x 73 mm ¹⁾	for lid	4	8612.140	8612.140	8612.140	8612.140	8612.150	8612.150	8612.150	8612.150	20
	for enclosure	4	8612.150	8612.150	8612.150	8612.150	8612.150	8612.150	8612.150	8612.150	20
Support strip ¹⁾	for lid	20	4694.000	4694.000	4694.000	4694.000	4695.000	4695.000	4695.000	4695.000	20
	for enclosure	20	4695.000	4695.000	4695.000	4695.000	4695.000	4695.000	4695.000	4695.000	20
Punched rail 18 x 38 mm ¹⁾	for lid	4	8612.240	8612.240	8612.240	8612.240	8612.250	8612.250	8612.250	8612.250	20
	for enclosure	4	8612.250	8612.250	8612.250	8612.250	8612.250	8612.250	8612.250	8612.250	20
Partial mounting plate	200 mm width	1	6730.310	6730.310	6730.310	6730.310	6730.310	6730.310	6730.310	6730.310	17
	500 mm width	1	6730.330	6730.330	6730.330	6730.330	6730.330	6730.330	6730.330	6730.330	17

Lock systems

Standard double-bit lock insert may be exchanged for 27 mm lock inserts, type A, see page Cat. 31, page 888.

To order primed consoles please add extension .800 to the Model No. Delivery times available on request.

¹⁾ Can be vertically mounted in lid and rear enclosure wall.



Interface flaps

as programming interface, for maintenance access and for connecting to network structures.

For Model No. see Innovations 2005/2006, page 200.



TP partial mounting plate

200 mm, 500 mm and 700 mm wide mounting plates are available as accessories. The screws fitted at the side enable several partial mounting plates to be bayed very quickly to form a continuous mounting area. See page 17 for Model No.

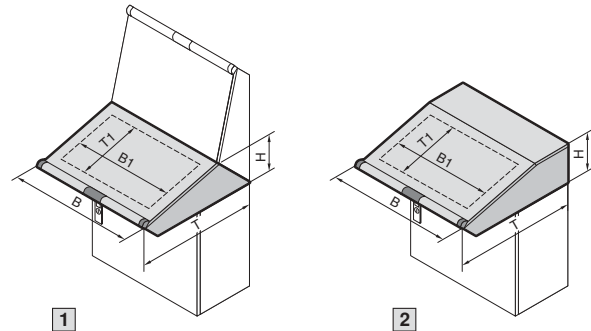

Material:

Sheet steel
Enclosure: 1.5 mm
Cover: 2.0 mm
Design handle strips: Aluminium
Corner protectors and lock lids:
Plastic, self-extinguishing

Surface finish:

Enclosure and cover:
Dipcoat-primed, powder-coated
in textured RAL 7035 on the
outside
Design handle strips:
Natural-anodised
Corner protectors and lock lids:
RAL 7015

Protection category:

IP 55 as per EN 60 529/10.91
When combined with console,
trim panel for console/desk unit,
gland plate and pedestal.



Rittal service:

- Other sizes, cut-outs and holes available on request
- Console centre section, with rear hinged lid, with mounting cut-out and CP-L support arm system reinforcement available upon request

Supply includes:

Enclosure with lid, hinged at rear, 2 stays with automatic locking and unlocking, Gland plate opening for running cables into the enclosure base.

- 1 Prepared for console: rear open up to the top
- 2 Rear with hinged lid

Detailed drawing,
see page 24.

		Packs of	1 Prepared for console				2 Rear with hinged lid				Page
Width (B) mm			600	800	1200	1600	600	800	1200	1600	
Height (H) mm			235	235	235	235	235	235	235	235	
Depth (T) mm			750	750	750	750	750	750	750	750	
Max. cut-out Console lid	Width (B1) mm		488	688	1088	1488	488	688	1088	1488	
	Depth (T1) mm		413	413	413	413	413	413	413	413	
Model No. TP			6714.500	6715.500	6716.500	6717.500	6710.500	6711.500	6712.500	6713.500	
Accessories											
Console/desk unit trim panel		1	6730.200	6730.210	6730.220	6730.230	-	-	-	-	17
Size 4 gland plate	solid	1	2562.400	-	2 x 2562.400	-	2562.400	-	2 x 2562.400	-	IN 06, p. 188
Size 5 gland plate	solid	1	-	2563.150	-	2 x 2563.150	-	2563.150	-	2 x 2563.150	IN 06, p. 188
Rail for interior installation	for width	4	5001.050	5001.051	5001.053	5001.055	5001.050	5001.051	5001.053	5001.055	20
Punched sections with mounting flanges 17 x 73 mm ¹⁾	in the depth	4	8612.150	8612.150	8612.150	8612.150	8612.150	8612.150	8612.150	8612.150	20
Support strip ¹⁾	in the depth	20	4695.000	4695.000	4695.000	4695.000	4695.000	4695.000	4695.000	4695.000	20
Punched rail 18 x 38 mm ¹⁾		4	8612.250	8612.250	8612.250	8612.250	8612.250	8612.250	8612.250	8612.250	20
Partial mounting plate	200 mm width	1	6730.310	6730.310	6730.310	6730.310	6730.310	6730.310	6730.310	6730.310	17
	500 mm width	1	6730.330	6730.330	6730.330	6730.330	6730.330	6730.330	6730.330	6730.330	17
Lock systems											
Standard double-bit lock insert may be exchanged for 27 mm lock inserts, type A, see page Cat. 31, page 888.											

To order primed desk units please add extension .800 to the Model No. Delivery times available on request.
¹⁾ Can be mounted in the lid and enclosure base.



Metal gland plates

For closing off the cable entry openings in the base when being used without pedestal, For Model No. see Innovations 2005/2006, page 188.



Cable glands

of polyamide or brass, Model No. see Cat. 31, page 972.

TopConsole System TP

Pedestals

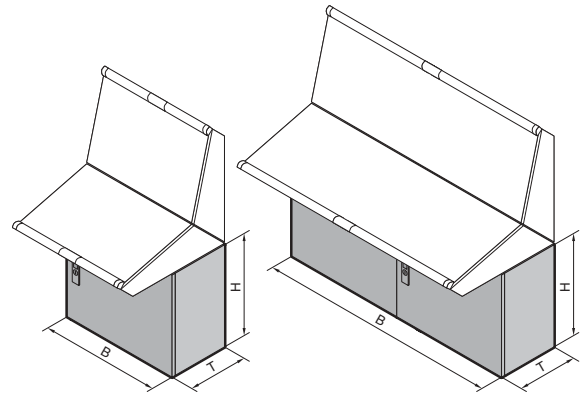

Material:
Sheet steel
Enclosure: 1.5 mm
Door: 2.0 mm
Mounting plate: 2.5 mm

Surface finish:
Enclosure and door:
Dipcoat-primed,
powder-coated on the outside in
Textured RAL 7035
Mounting plate: Zinc-plated

Protection category:
IP 55 to EN 60 529/10.91
(when using the relevant trim
panel, see page 16, or fit a desk
unit as well as choosing a rele-
vant gland plate, see page 15)



Rittal service:

Other sizes, cut-outs and holes
available on request.

Supply includes:

Enclosure, open at the top, door
or double door with locking rod
(with 400 mm depth at the front,
with 500 mm depth at the front
and rear), depth-adjustable
mounting plate, open base for
individual cable entry options.

Detailed drawing,
see page 25.

Width (B) mm	Packs of	600	800	1200	1600	600	800	1200	1600	Page
Height (H) mm		675	675	675	675	675	675	675	675	
Depth (T) mm		400	400	400	400	500	500	500	500	
Model No. TP		6700.500	6701.500	6702.500	6703.500	6704.500	6705.500	6706.500	6707.500	
Door(s)		1	1	2	2	1/1	1/1	2/2	2/2	

Base/plinth											
Components front and rear	Height 100 mm	1 set	8601.600	8601.800	8601.200	8601.920	8601.600	8601.800	8601.200	8601.920	18
	Height 200 mm	1 set	8602.600	8602.800	8602.200	8602.920	8602.600	8602.800	8602.200	8602.920	18
Trim panels (sides)	Height 100 mm	1 set	8601.040	8601.040	8601.040	8601.040	8601.050	8601.050	8601.050	8601.050	18
	Height 200 mm	1 set	8602.040	8602.040	8602.040	8602.040	8602.050	8602.050	8602.050	8602.050	18
Cross-member, adjustable		2	8601.450	8601.450	8601.450	8601.450	8601.450	8601.450	8601.450	8601.450	19

Accessories											
Pedestal trim plate		1	6730.000	6730.010	6730.020	6730.030	6730.100	6730.110	6730.120	6730.130	16
Rail for interior installation	for height	4	5001.050	5001.050	5001.050	5001.050	5001.050	5001.050	5001.050	5001.050	20
Punched sections with mounting flanges, 17 x 73 mm	in the depth	4	8612.140	8612.140	8612.140	8612.140	8612.150	8612.150	8612.150	8612.150	20
Punched rail 18 x 38 mm	in the depth	4	8612.240	8612.240	8612.240	8612.240	8612.250	8612.250	8612.250	8612.250	20
Mounting bars	in the depth	20	4694.000	4694.000	4694.000	4694.000	4695.000	4695.000	4695.000	4695.000	20
Punched sections with mounting flanges, 17 x 73 mm	for door	4	8612.050	-	8612.050	-	8612.050	-	8612.050	-	20
Support strips	for door	20	4596.000	4598.000	4596.000	4598.000	4596.000	4598.000	4596.000	4598.000	Cat. 31, p. 895
Cable clamp rail		1	5001.080	5001.081	5001.083	5001.084	5001.080	5001.081	5001.083	5001.084	23
Wiring plan pocket		1	4116.500	4118.500	4116.500	4118.500	4116.500	4118.500	4116.500	4118.500	IN 06, p. 181

Lock systems

Standard double-bit lock insert may be exchanged for 27 mm lock inserts, type A, see page Cat. 31, page 888 and Ergoform-S lock system, see Cat. 31, page 885.

To order primed pedestals please add extension .800 to the Model No. Delivery times available on request.



Gland plates

- See page 15 for gland plates with different depths.
- Sections for cable entry, see page 16.
- Cable entry plates, see page 15.



Hinges 180°

For retrospective conversion of standard doors with 130° hinges, including assembly parts.

Packs of	Model No. SZ
6	4189.000



Gland plates

Select suitable gland plates depending on the application. The following examples illustrate the individuality of cable entry design. Potential equalisation is provided via assembly components and earthing points.

Design	For console width mm			
	600	800	1200	1600
	Model No.			
1	5001.210	5001.211	5001.213	5001.233
2	5001.214	5001.215	5001.217	5001.234
3	5001.218	5001.219	5001.221	5001.235
4	5001.222	5001.223	5001.225	5001.236
6	5001.226 ¹⁾	5001.227 ¹⁾	5001.229 ¹⁾	5001.237

¹⁾ Cable entry grommets, see page 16.

Combination options:

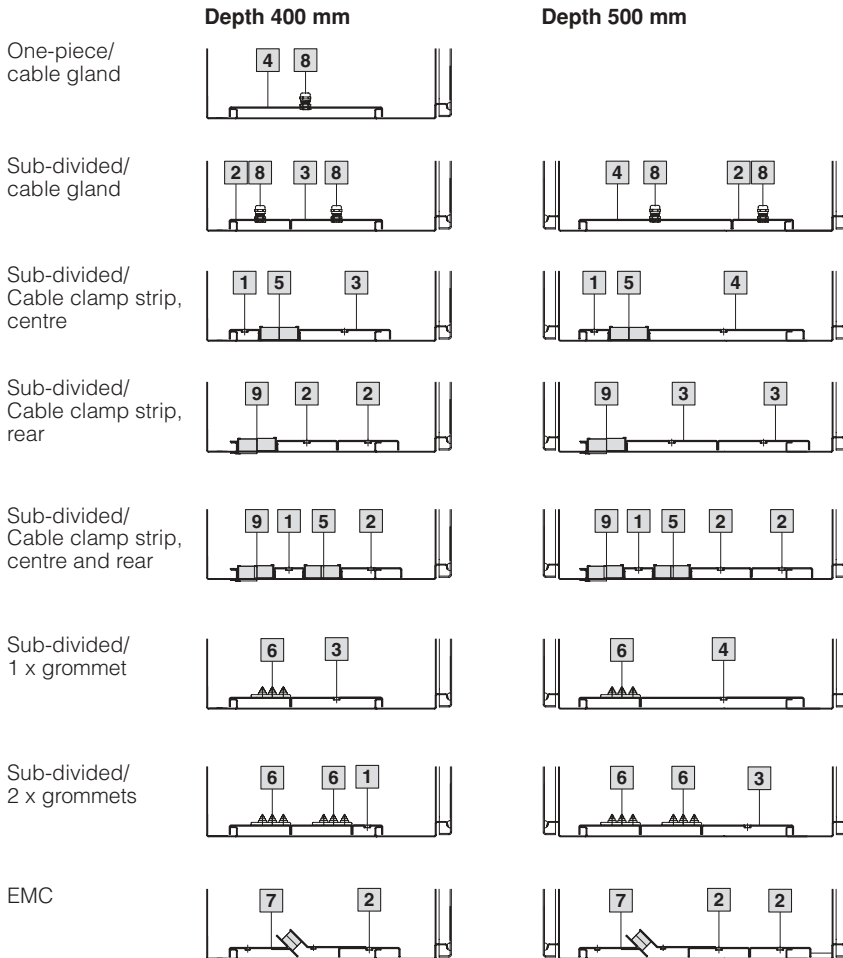

Material:

Sheet steel, zinc-plated

Protection category:

IP 55 if mounted correctly.

Supply includes:

Assembly parts.

Note:

The base opening is sub-divided to give greater stability and universal cable entry in the case of 1200 and 1600 mm console width and these can be fitted differently.

Key:

- 1 Gland plate, depth 50 mm
- 2 Gland plate, depth 100 mm
- 3 Gland plate, depth 150 mm
- 4 Gland plate, depth 250 mm
- 5 Section for cable entry, centre, depth 63 mm, see page 16.
- 6 Cable entry plate, depth 100 mm, see above.
- 7 EMC gland plate, depth 222 mm, see Cat. 31, page 958.
- 8 Cable glands, see Cat. 31, page 972.
- 9 Section for cable entry, rear, depth 63 mm, see page 16.

Order example:

TP TopConsole pedestal 6706.500 (W/H/D 1200 x 675 x 500 mm)

- On left, two-part gland plate with cable clamp strip
- On right, two-part gland plate

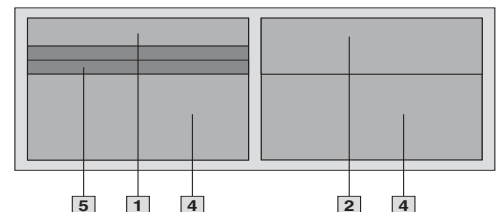

You will need:

- 1 1 gland plate, depth 50 mm, 5001.213
- 2 1 gland plate, depth 100 mm, 5001.217
- 4 2 gland plates, depth 250 mm, 5001.225
- 5 2 sections for cable entry, centre, TS 8802.120, see page 16. (Packs of 4)

TopConsole System TP

System accessories



Section for cable entry, centre

For top-mounting on the gland plates.

- Easier mounting
- Full-surface support

Supply includes:

1 set =
2 sections for base plate,
each with bonded seal.

For console width mm	Packs of	Model No. TS
600	1 set	8802.060
800	1 set	8802.080
1200	2 sets	8802.120
1600	2 sets	8802.160



Section for cable entry, rear

Unlike the section for cable entry, centre, the rear section is mounted directly onto the base opening. In this way, the cables may be routed directly onto a cable clamp rail without large bending radii.

Material:

Extruded aluminium section,
PU foam seal,
cross-section: 30 x 25 mm

Protection category:

IP 55 if mounted correctly.

For console width mm	Packs of	Model No. TS
600	1 set	8802.065
800	1 set	8802.085
1200	2 sets	8802.125
1600	2 sets	8802.165

Supply includes:

1 set =
1 section for base opening,
1 section for base plate,
each with bonded seal.



Cable entry grommets

In conjunction with the cable entry plate, simple and fast sealing of cables inserted in the base area of enclosures.

Protection category:

IP 55 if mounted correctly.

Cable per grommet	Max. Ø mm	Packs of	Model No. TS
8	13	25	4316.000
3	21	25	4317.000
1	47	25	4318.000



Connector grommets

Suitable for cable diameters from 8 to 36 mm.

Packs of	Model No. TS
10	4311.000



Trim plate for pedestal

For covering the complete top opening when using the pedestal on its own.

Material:

Sheet steel

Colour:

Textured RAL 7035

Protection category:

IP 55

Supply includes:

Assembly parts.

For pedestal		Model No. TP
Width mm	Depth mm	
600	400	6730.000
800		6730.010
1200		6730.020
1600		6730.030
600	500	6730.100
800		6730.110
1200		6730.120
1600		6730.130



1



2

Trim plate

for console/desk unit

For covering the entire top opening when used alone.

Material:
Sheet steel

Colour:
Textured RAL 7035

Protection category:
IP 55

Supply includes:
Assembly parts.

1 Console used as a wall-mounted enclosure

2 Trim panel on desk unit

For console Width mm	Model No. TP
600	6730.200
800	6730.210
1200	6730.220
1600	6730.230

Note:

Can be used with desk unit prepared for an upright console as well.

Detailed drawing,
see page 26.



Partial mounting plates, locatable into rails

For installation in:

- Console and desk unit on the interior installation system rails
- Punched sections with mounting flanges or support strips fitted to the side of the pedestal in the depth
- Other enclosures mounted on rails with 25 mm pitch pattern punchings

For easy mounting on pre-fitted assembly screws. Can be bayed using the side screws.

Material:
Sheet steel, zinc-plated

Supply includes:
Assembly parts.

Width mm	Height mm	Packs of	Model No. TP
200	435	1	6730.310
500	435	1	6730.330
700	435	1	6730.340

For console/desk unit Width mm	Max. partial mounting plate installation
600	1 x TP 6730.330
800	1 x TP 6730.340
1200	2 x TP 6730.310 1 x TP 6730.340
1600	3 x TP 6730.330

Detailed drawing,
see page 26.



Attachment rail

For accessories such as a scanner holder, printer shelf, etc.

Mounted using the existing front holes in the side groove between the pedestal and the desk unit. The enclosure protection category remains unaffected by this installation. No additional reinforcements are required for the pedestal.

Holes can be drilled in the attachment rail prior to installation (e.g. for fitting screws, self-tapping screws or rivets).

Suitable for pedestal Depth mm	Model No. TP
400	6730.500
500	6730.510

Material:

Rail: Sheet steel, zinc-plated, passivated
Cover caps: Plastic, self-extinguishing, similar to RAL 7024

Supply includes:
Assembly parts.

TopConsole System TP

System accessories



Baying rail

For baying the consoles at the installation site. Fitted in the side groove between the pedestal and the desk unit.

Material:

Rail: Sheet steel, zinc-plated, passivated
Cover caps: Plastic, self-extinguishing, similar to RAL 7024

Supply includes:

Assembly parts and baying seals.

Suitable for pedestal Depth mm	Model No. TP
400	6730.520
500	6730.530



Base/plinth components front and rear

Base/plinth component consisting of one trim panel and two pre-configured corner pieces. In 200 mm high base/plinth components, one trim panel is divided into two for cable entry.

Material:

Sheet steel, spray-finished in RAL 7022
Cover caps plastic RAL 9005/7035

Supply includes:

1 set =
2 base/plinth components, 4 cover caps,
4 screws and captive nuts M12
for attachment to the enclosure.

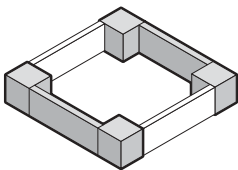

For console width mm	Model No. TS	
	100 mm high	200 mm high
600	8601.600	8602.600
800	8601.800	8602.800
1200	8601.200	8602.200
1600	8601.920	8602.920

+ Accessories:

Base assembly plate SO 2817.000, see page 18.
Base/plinth baying brackets TS 8601.100, see Cat. 31, page 838.

Detailed drawing,
see Cat. 31, page 836.

German patent no. 198 60 408



Base/plinth trim, side

For mounting between the base/plinth components. At 200 mm height, two 100 mm base/plinth trims may be used.

Material:

Sheet steel, spray-finished in RAL 7022

Supply includes:

1 set =
2 base/plinth trim panels, including parts for attaching to the base/plinth components.

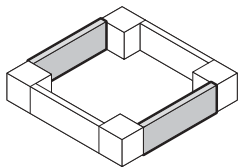

For console depth mm	Model No. TS	
	100 mm high	200 mm high
400	8601.040	8602.040
500	8601.050	8602.050

+ Accessories:

Fastening bolts for baying base/plinth trim, see page 19.

Detailed drawing,
see Cat. 31, page 836.



Base assembly plate for base/plinth

For fastening the plinth to the floor without moving the enclosure or the bayed enclosure suite. For assembly screws up to 12 mm Ø.

Material:

Sheet steel, zinc-plated, passivated

Packs of	Model No. SO
10	2817.000



Fastening bolts

for base/plinth

For mounting on base/plinth trim panels, side. The lockable assembly bolt allows the installation of cable clamp rails and standard C rails.

Material:

Hexagon steel, zinc-plated, passivated, 19 mm across flats

For base/plinth trim panel Height mm	Packs of	Model No. SZ
100	10	2819.000
200	10	2819.200

+ Accessories:

Cable clamp rail, see Cat. 31, page 979.

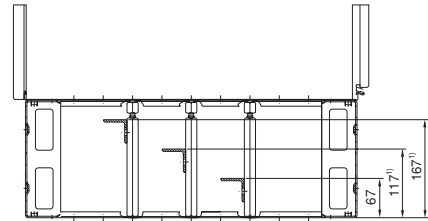

¹⁾ only for height 200 mm



Cross-member

for TS, PC, IW, ES, TP adjustable

To increase stability, the cross-member is positioned 138 mm above the base frame of the pedestal at the front and rear. For deeper pedestals, the rear part may be extended and screw-fastened again. For screw-fastening to the floor and pedestal with mounting hole at the sides front and rear. The castors and levelling feet may be secured to the welded nuts M12.

Material:

Sheet steel, spray-finished

Colour:

RAL 7015

Note:

For mobile use, the cross member must be screw-fastened twice in the corners using additionally prepared holes to the pedestal.

Enclosure depth mm	L1	L2	Packs of	Model No. TS
400	644	275	2	8601.450
500	744	375		

+ Accessories:

Attachment opportunities for

- Twin castors PC 4634.500, see Cat. 31, page 848.
- Levelling feet PS 4612.000, see Cat. 31, page 848.

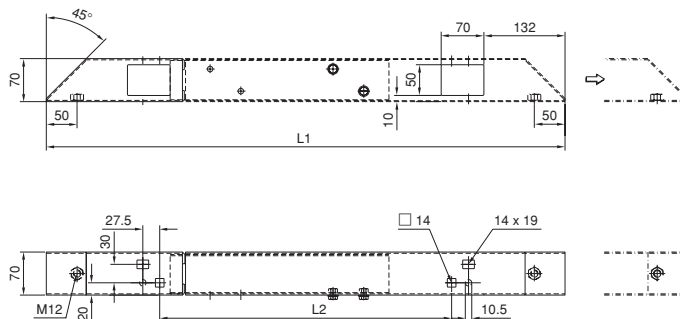

TopConsole System TP

System accessories



Rails for interior installation

For attaching to the existing threaded studs; horizontally in console and desk unit; vertically at the side in the pedestal.

With TS system punchings on three sides.

Material:

Sheet steel, zinc-plated, passivated

Supply includes:

Assembly parts.



For pedestal Height mm	Packs of	Model No. SZ
675	4	5001.050

For desk unit/console Width mm	Packs of	Model No. SZ
600	4	5001.050
800	4	5001.051
1200	4	5001.053
1600	4	5001.055

Installation accessories Enclosure pedestal	Model No.		Cat. 31, page
	for depth mm		
	400	500	
1 TS punched section with mounting flange, 17 x 73 mm for the outer level	8612.140	8612.150	921
2 TS support strip for the outer level	4694.000	4695.000	924
3 TS punched rail 18 x 38 mm	8612.240	8612.250	923
4 PS punched rail 23 x 23 mm with mounting bracket TS 8800.370	4169.000	4170.000	925
Installation accessories Enclosure console/desk unit	for all widths		
1 TS punched section with mounting flange, 17 x 73 mm for the inner level	8612.050		921
2 TS support strip for the outer level	4695.000		924
3 TS punched rail 18 x 38 mm	8612.250		923

Pedestal

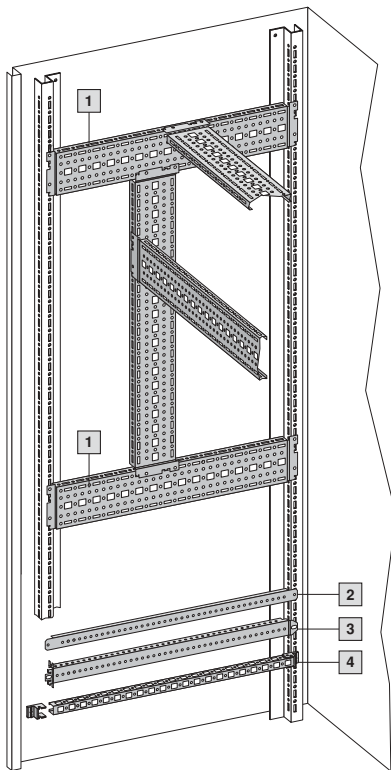

Console/desk unit

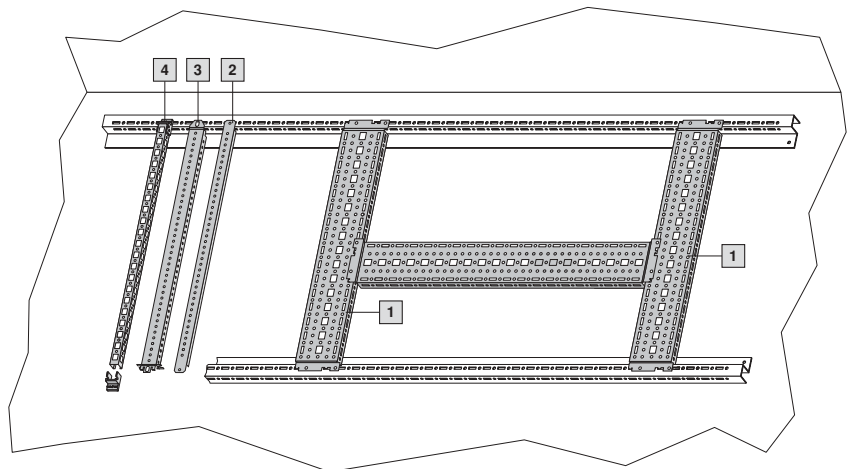



Cable conduit

The stable, robust corrugated tubes ensure secure cable routing between the machine and control console or enclosure.

The split version offers the following benefits:

- Problem-free retrospective installation
- Simple insertion of pre-assembled cables
- Faster insertion of cables, particularly with long sections

Material:

Polyamide, self-extinguishing to UL 94

Nominal width	Inside Ø in mm	Design	Model No. SZ
50	46	Solid	2589.140
50	43	Split	2589.150
29	27	Solid	2589.100

Packs of 25 m



1

2



3

4

Connection accessories

For cable conduit

Versions with a nominal width of 29 mm are easily inserted into a through-hole. There is no need for an internal thread or lock nut.

Material:

Polyamide, self-extinguishing to UL 94

Supply includes:

SZ 2589.160/SZ 2589.170:
2 connection glands,
2 hex nuts.

SZ 2589.110/SZ 2589.120:
2 plug-in connections.

Nominal width	Design	Straight	Angled	Mounting hole Ø in mm	Packs of	Model No. SZ
1 50	Screwed cable gland	■		51	2	2589.160
2 50	Screwed cable gland		■	51	2	2589.170
3 29	Plug-in connection	■		37	2	2589.110
4 29	Plug-in connection		■	37	2	2589.120



Support

For cable conduit

Material:

Polyamide, self-extinguishing to UL 94

Supply includes:

Support

Note:

Attachment using screws M6 or alternatively screws Ø 5.5 mm, see Cat. 31, page 937.

Nominal width	Packs of	Model No. SZ
50	10	2589.180
29	10	2589.130



Mounting on pedestal CP 6141.100, see Cat. 31, page 232



Mounting on Compact Panel CP 6340.000 - .420, see Cat. 31, page 183

TopConsole System TP

System accessories

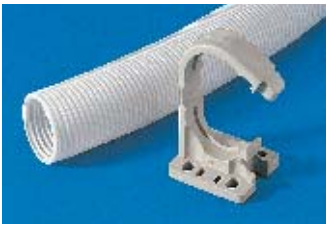

Cable conduit and cable conduit holder

For secure cable routing e.g. from the enclosure or mounting plate to the door. Option of attaching the cable conduit holder to the punched door strips or rails for interior installation with no drilling required.

Attachment facility for standard commercially available cable ties is provided on the cable conduit holder, so that cables may be attached upon entry to/exit from the cable conduit.

Material:

Cable conduit: Polythene
Cable conduit holder: Polyamide



Cable conduit

Internal Ø mm	Packs of	Model No. SZ
16	25 m	2595.000
29	25 m	2589.000
36	25 m	2596.000
48	25 m	2590.000

Cable conduit holder

For cable conduit Ø mm	Packs of	Model No. SZ
16	20	2593.000
29	20	2591.000
36	20	2594.000
48	20	2592.000



Wall mounting bracket

For the attachment of consoles when used alone, e.g. as a display enclosure.

Material:

Sheet steel, zinc-plated, passivated

Supply includes:

Assembly parts for mounting on the enclosure.

Note:

Additional holes in the console required.

Wall distance (A) mm	Packs of	Model No. SZ
40	1	2503.000¹⁾
	4	2503.010
10	1	2508.000¹⁾
	4	2508.010

¹⁾ Without assembly parts.

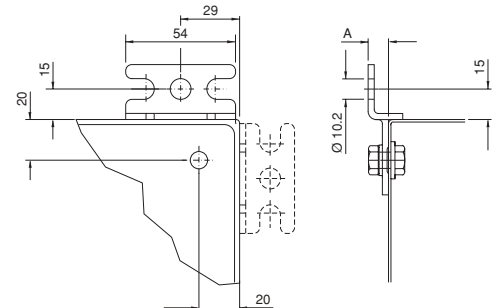



Cable clamp rail

C section

For strain relief with cable entry. The length of the cable clamp rail is tailored to the width of the mounting plate. The mounting bracket included with the supply supports three different installation situations on the mounting plate:

- 1 straight, at a distance of 23 mm from the mounting plate
- 2 straight, at a distance of 10 mm from the mounting plate
- 3 tilted, towards the mounting plate

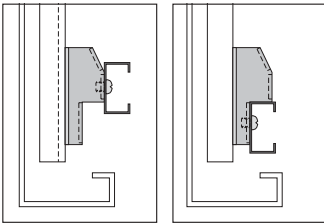

1

2

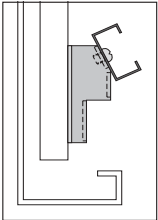

3

Material:

Sheet steel, zinc-plated, passivated

Supply includes:

Two mounting brackets and assembly screws.

For pedestal Width mm	Length mm	Model No. CM
600	499	5001.080
800	699	5001.081
1200	1099	5001.083
1600	1499	5001.084 ¹⁾

¹⁾ Including 3 mounting brackets.

+ Accessories:

Cable clamps for C rails

For cable diameter mm	Packs of	Model No. DK
6 – 14	25	7077.000
12 – 18	25	7078.000
18 – 22	25	7097.000
22 – 26	25	7097.220
26 – 30	25	7097.260
30 – 34	25	7097.300
34 – 38	25	7097.340
38 – 42	25	7098.000
42 – 56	25	7098.100
56 – 64	25	7099.000



Signal pillars

With LED or incandescent lamp, compact or modular, plus an extensive range of accessories. See Catalogue 31, from page 1041.



TFT monitor

See Innovations 2005/2006, page 197.



Pull-out keyboard

For installation in the desk unit. See Innovations 2005/2006, page 198.



Built-in keyboard 19"/4 U

See Innovations 2007, page 68.

Other accessories

can be found in Catalogue 31, such as

- **Viewing panels/operating panels** from page 877
- **Wiring plan pockets** from page 897
- **Partial mounting plates** from page 913
- **System lights** from page 954
- **Earthing** from page 960
- **Signal pillars** from page 1041
- **Cable ducts** page 978
- **Cable glands** from page 973
- **Cable gland** from page 972
- **Power distribution components** from page 299
- **System climate control** from page 579
- **Wiring plan lectern** from page 896
- **IW** from page 238
- **Comfort Panel** Innovations 2005/2006, from page 24
- **Support arm system CP-L** from page 200
- **Interface flaps** Innovations 2005/2006, page 200
- **USB extension with wall connection** Innovations 2007, page 68

TopConsole System TP

Technical details

Consoles

Page 12

600/800 mm width

TP 6720.500, TP 6721.500
TP 6724.500, TP 6725.500

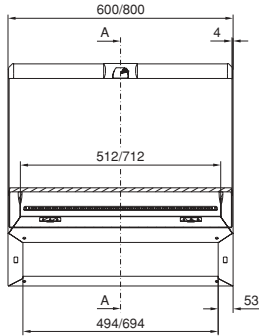

1200/1600 mm width

TP 6722.500, TP 6723.500
TP 6726.500, TP 6727.500

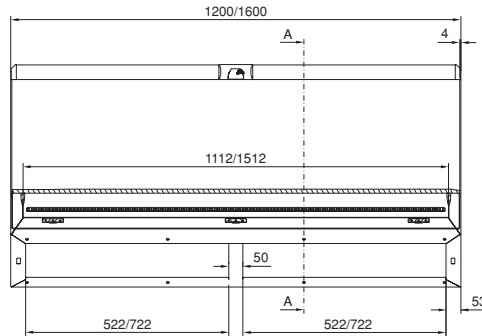

Section A – A

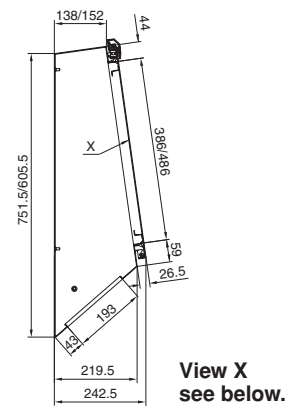

Desk units, prepared for consoles

Page 13

600/800 mm width

TP 6714.500, TP 6715.500

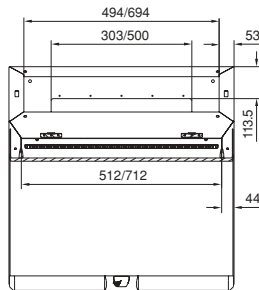
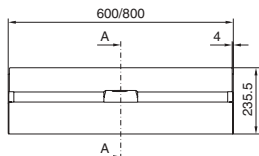

1200/1600 mm width

TP 6716.500, TP 6717.500

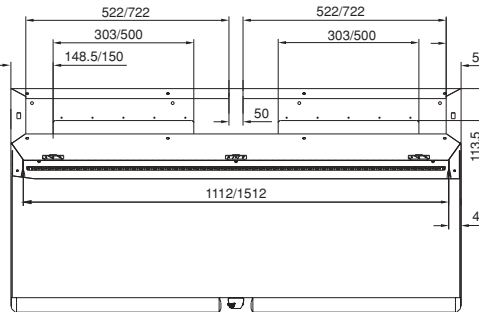
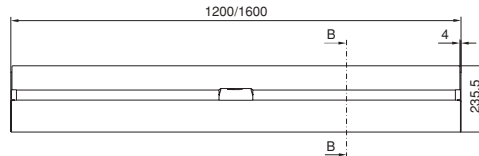

Section A – A

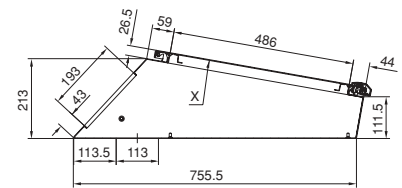

View X
see below.

Desk units, rear with hinged lid

Page 13

600/800 mm width

TP 6710.500, TP 6711.500

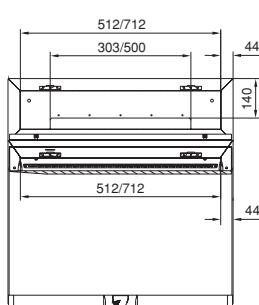
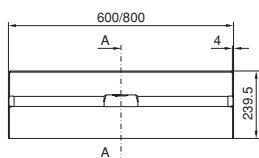

1200/1600 mm width

TP 6712.500, TP 6713.500

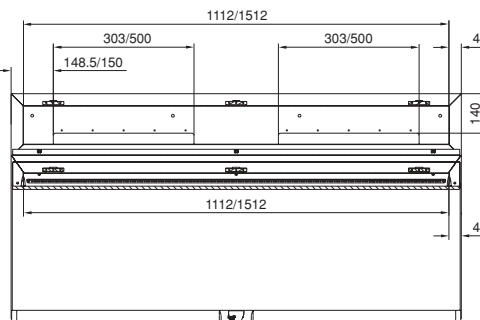
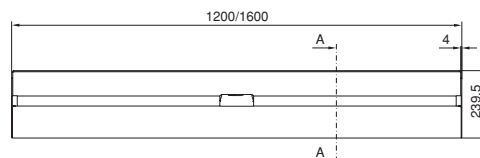

Section A – A

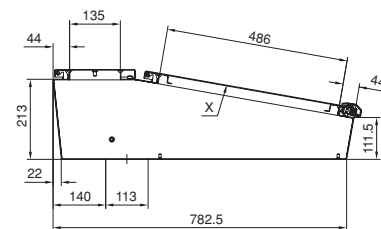

Detail X

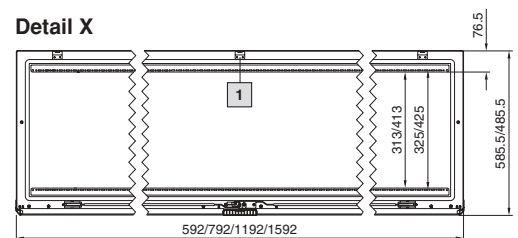

1 Not needed with 600/800 mm width

Pedestals, 400 mm deep

Page 14

600/800 mm width
TP 6700.500, TP 6701.500

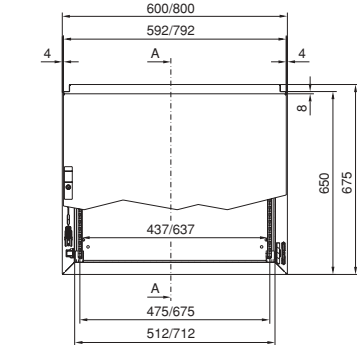

1200/1600 mm width
TP 6702.500, TP 6703.500

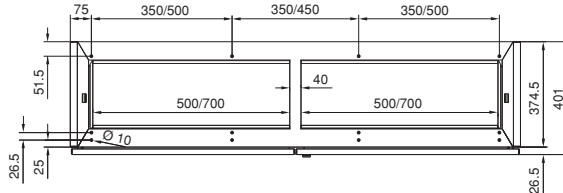
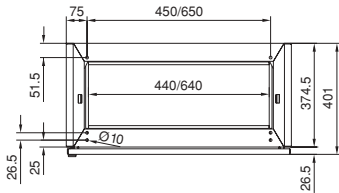
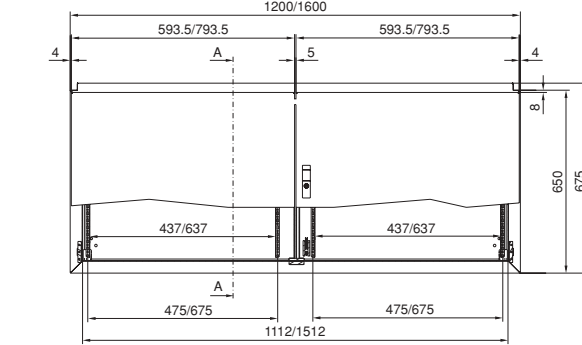

Section A – A

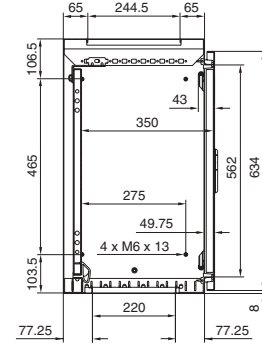

Mounting plate

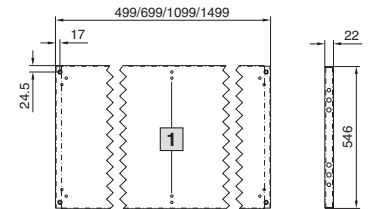

1 Not needed with 600/800 mm width

Pedestals, 500 mm deep

Page 14

600/800 mm width
TP 6704.500, TP 6705.500

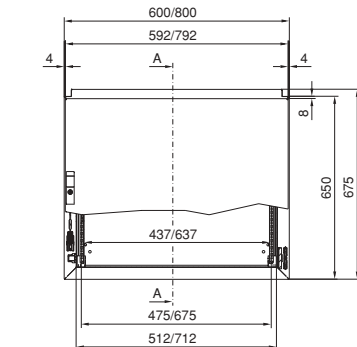

1200/1600 mm width
TP 6706.500, TP 6707.500

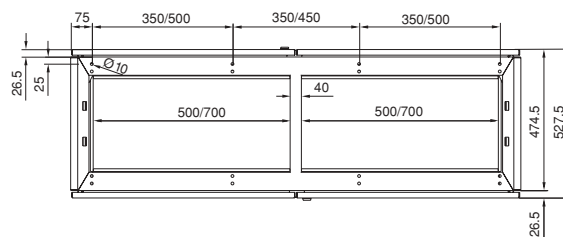
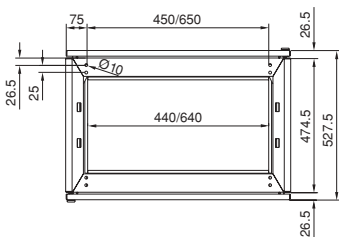
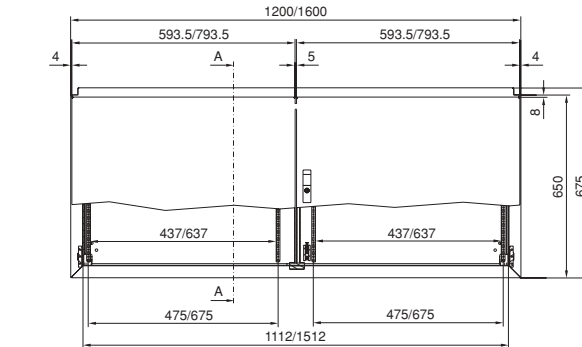

Section A – A

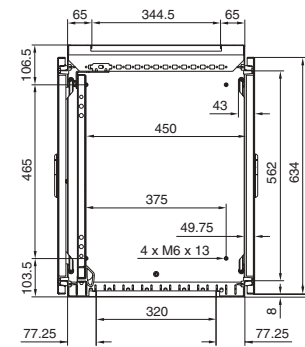

Mounting plate

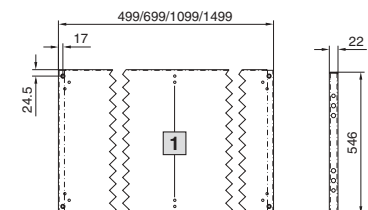

1 Not needed with 600/800 mm width

Index/List of model numbers

A

Attachment rail 17

B

Base assembly plate
– for base/plinth 18
Base/plinth components
– front and rear 18
Base/plinth trims
– side 18
Baying rail 18

C

Cable clamp rail, C rail 10, 23
Cable conduit 21
Cable conduit/cable conduit
holder 22
Cable entry
– on gland plate 16
Cable entry grommets 16
Combination options 10
Connection accessories
– for cable conduit 21
Connector grommets 16
Consoles TP 12
Cross-member, adjustable 19

D

Desk units TP 13

F

Fastening bolts
– for base/plinth 19

G

Gland plates 15

P

Partial mounting plates
– locatable 17
Pedestals TP 14
Plate
– for base mounting 18

R

Rails for interior installation 20

S

Section for cable entry
– central 16
– rear 16
Supports
– for cable conduit 21

T

TopConsole System TP
– Consoles 12
– Desk units 13
– Pedestals 14
Trim panel
– for console/desk unit 17
– for pedestal 16

W

Wall mounting bracket 22

We reserve the right to further developments and technical modifications of our products. Such modifications, along with errors and printing errata, shall not constitute grounds for compensation. We refer customers to our Terms of Sale and Delivery.

Model No.	Page	Model No.	Page	Model No.	Page	Model No.	Page	Model No.	Page
2503.000	22	4318.000	16	5001.237	15	6730.030	16	8601.200	18
2503.010	22	5001.050	20	6700.500	14	6730.100	16	8601.450	19
2508.000	22	5001.051	20	6701.500	14	6730.110	16	8601.600	18
2508.010	22	5001.053	20	6702.500	14	6730.120	16	8601.800	18
2589.000	22	5001.055	20	6703.500	14	6730.130	16	8601.920	18
2589.100	21	5001.080	23	6704.500	14	6730.200	17	8602.040	18
2589.110	21	5001.081	23	6705.500	14	6730.210	17	8602.050	18
2589.120	21	5001.083	23	6706.500	14	6730.220	17	8602.200	18
2589.130	21	5001.084	23	6707.500	14	6730.230	17	8602.600	18
2589.140	21	5001.210	15	6710.500	13	6730.310	17	8602.800	18
2589.150	21	5001.211	15	6711.500	13	6730.330	17	8602.920	18
2589.160	21	5001.213	15	6712.500	13	6730.340	17	8802.060	16
2589.170	21	5001.214	15	6713.500	13	6730.500	17	8802.065	16
2589.180	21	5001.215	15	6714.500	13	6730.510	17	8802.080	16
2590.000	22	5001.217	15	6715.500	13	6730.520	18	8802.085	16
2591.000	22	5001.218	15	6716.500	13	6730.530	18	8802.120	16
2592.000	22	5001.219	15	6717.500	13	7077.000	23	8802.125	16
2593.000	22	5001.221	15	6720.500	12	7078.000	23	8802.160	16
2594.000	22	5001.222	15	6721.500	12	7097.000	23	8802.165	16
2595.000	22	5001.223	15	6722.500	12	7097.220	23		
2596.000	22	5001.225	15	6723.500	12	7097.260	23		
2817.000	18	5001.226	15	6724.500	12	7097.300	23		
2819.000	19	5001.227	15	6725.500	12	7097.340	23		
2819.200	19	5001.229	15	6726.500	12	7098.000	23		
4189.000	14	5001.233	15	6727.500	12	7098.100	23		
4311.000	16	5001.234	15	6730.000	16	7099.000	23		
4316.000	16	5001.235	15	6730.010	16	8601.040	18		
4317.000	16	5001.236	15	6730.020	16	8601.050	18		

Everything from a single source for the human/machine interface



Command Panel



Support arm systems



Stand systems



Industrial workstations



PC enclosure systems



System accessories



Service

07/07 · E173

Rittal GmbH & Co. KG · Postfach 1662 · D-35726 Herborn
Telephone: +49(0)2772 505-0 · Telefax: +49(0)2772 505-2319 · eMail: info@rittal.de · www.rittal.com



Switch to perfection **RITTAL**